



BOOKCASES

Yarbrough Furniture Designs, Inc



Read Study Learn

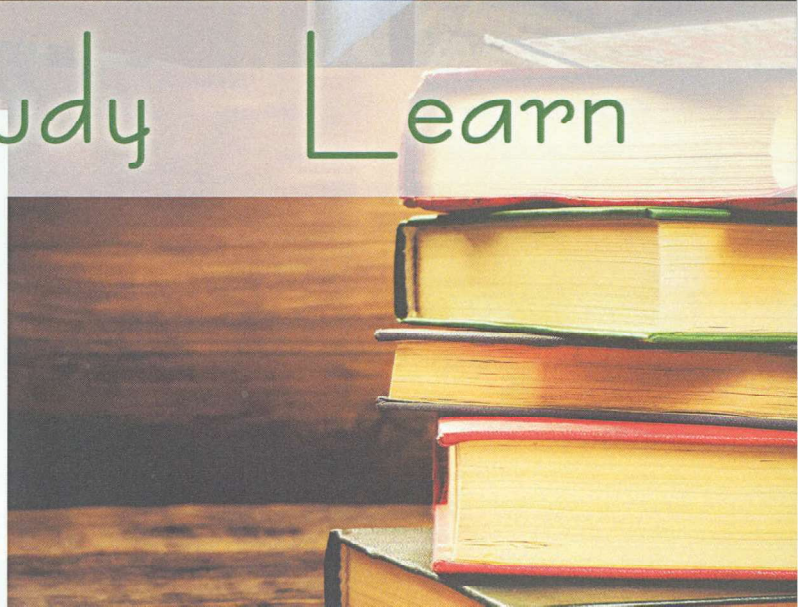



BOOKCASES

Yarbrough Furniture Designs, Inc

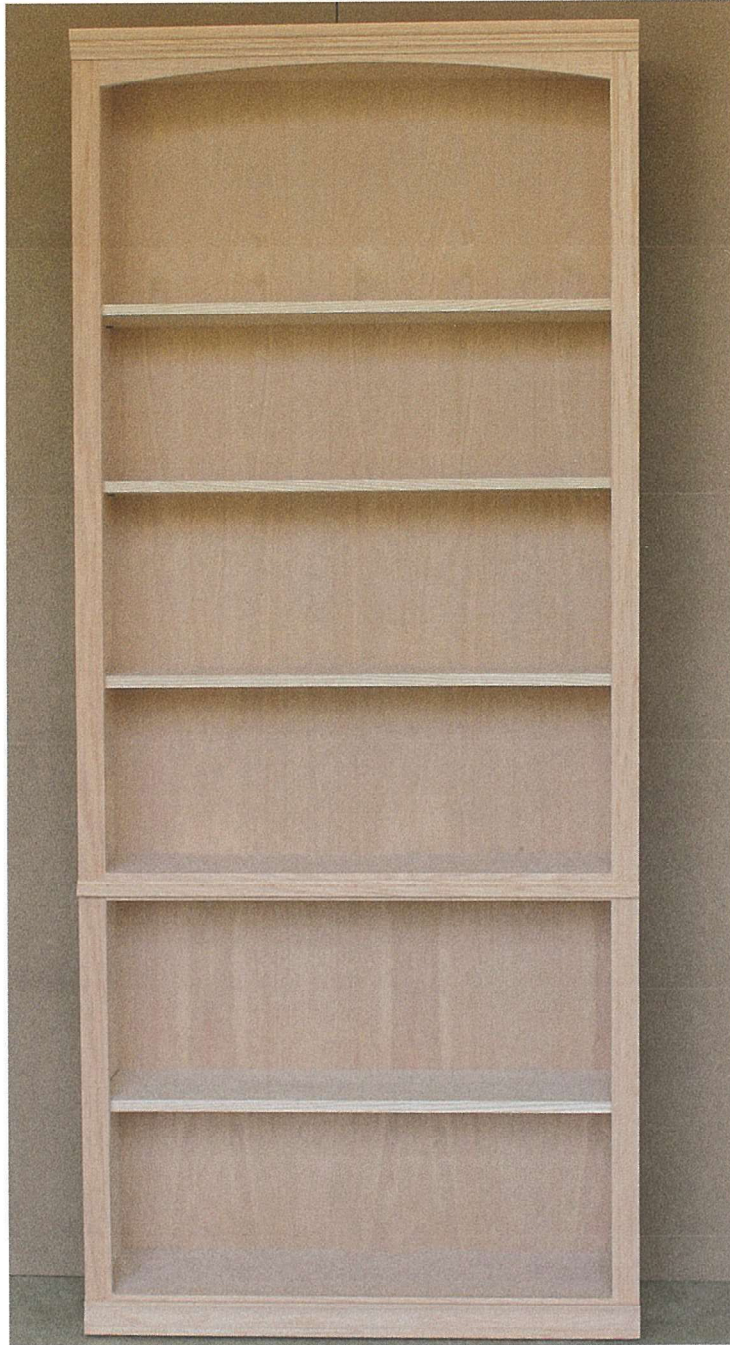

Red River Shaker



BOOKCASES

Yarbrough Furniture Designs, Inc

Oxford Bookcases

- Finished Tops with Large Crown Molding
- Deep Fluted Face Frame
- Broad Toe Kick

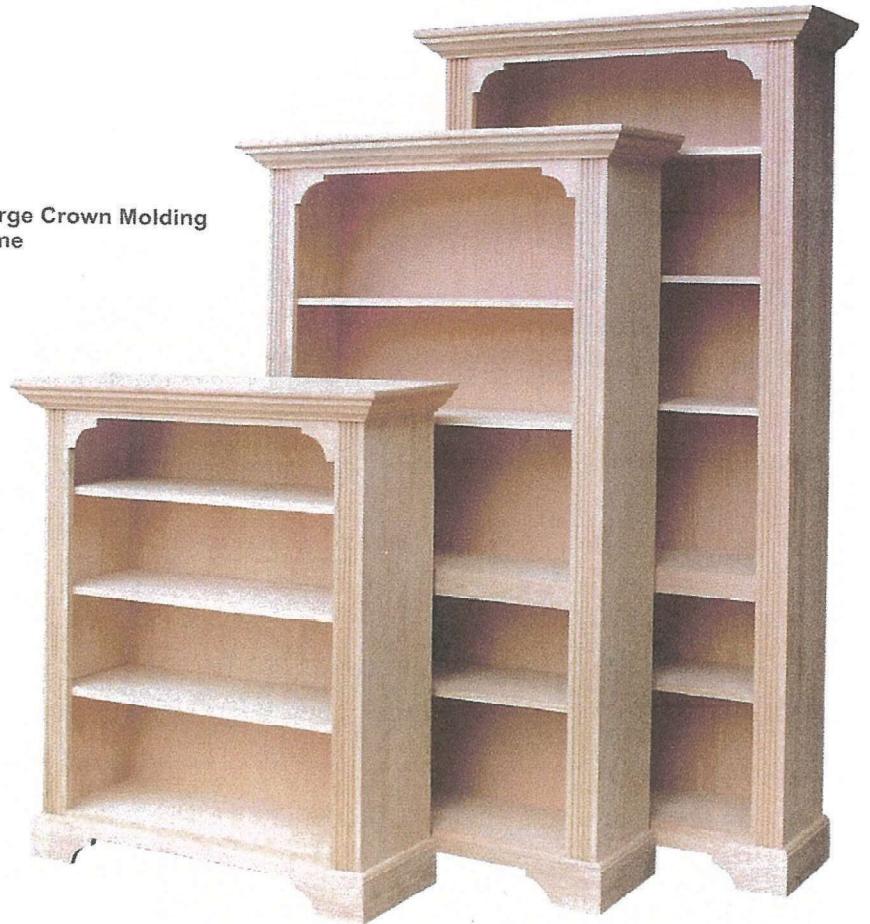

Ornate Bookcase



BOOKCASES

Yarbrough Furniture Designs, Inc



Embassy Bookcases

Embassy, Tuscany, and Oxford Bookcases Detail

Features:

- Finished Tops with Large Crown Molding
- Deep Fluted Face Frame
- Broad Toe Kick

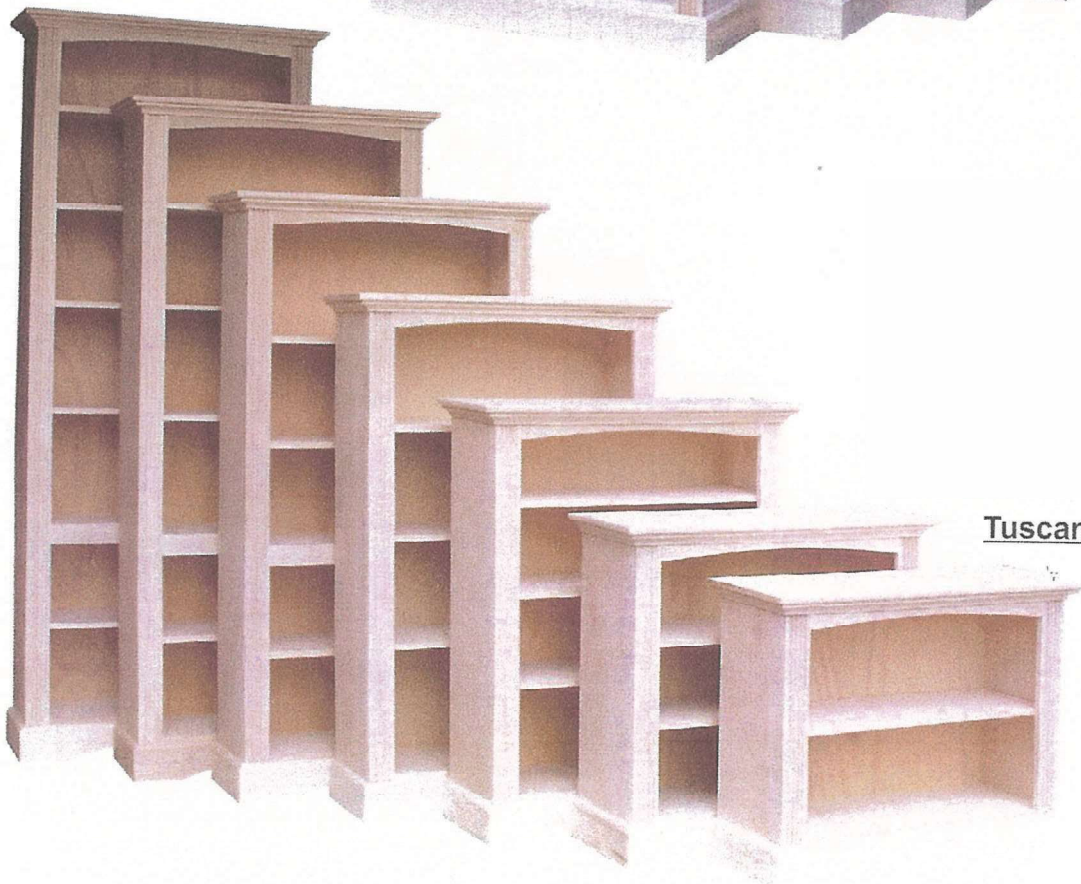
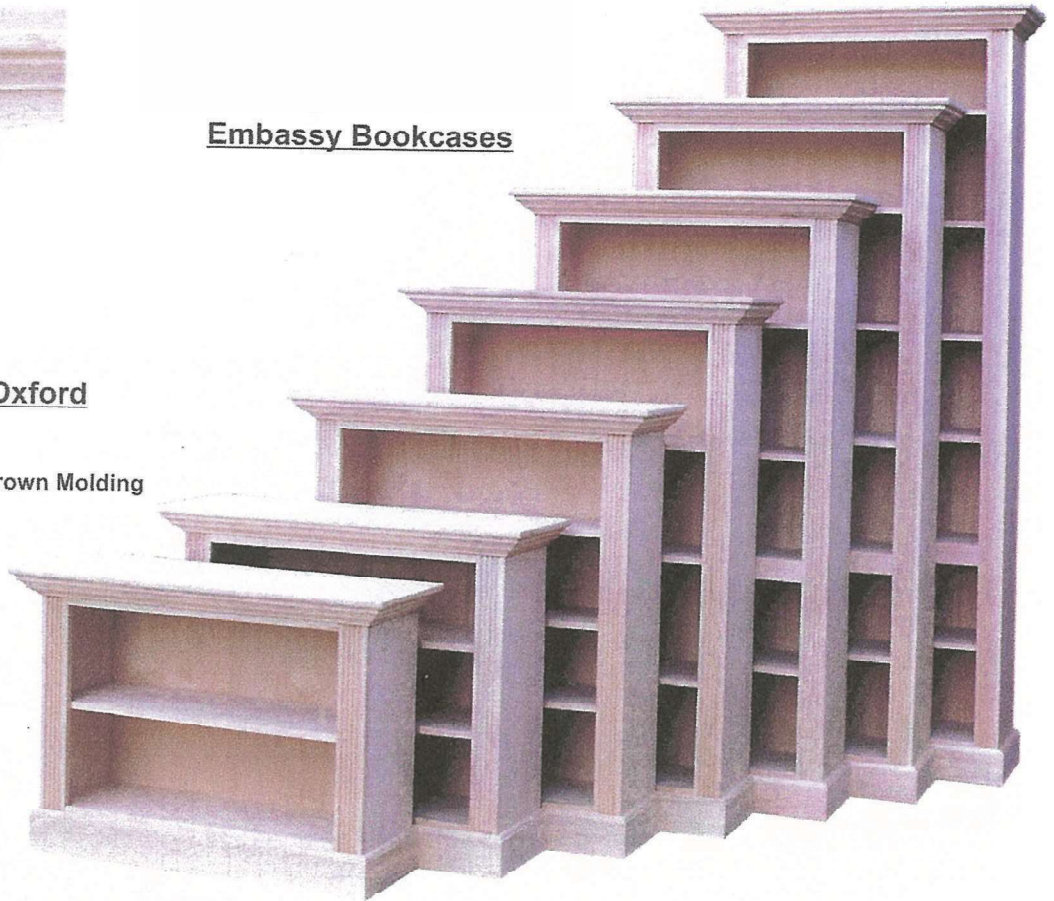

Tuscany Bookcases



BOOKCASES

Yarbrough Furniture Designs, Inc



Lawyer Bookcase

2 Door - 31" h x 32" w

3 Door - 42 1/4" h x 32" w

4 Door - 59" h x 32" w

5 Door - 72 3/4" h x 32" w



BOOKCASES

Yarbrough Furniture Designs, Inc

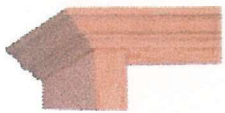

Traditional Detail

Traditional Bookcase Wall

RR9684TRW-12 12 Total Adj Shelves
Outset Doors
100w x 84t x 14d (Outside Dimensions)
Consists of 2-30w x 84t Bookcases w/ door kits
1-36w x 84t Bookcase w/ door kit
Also Available 16" Deep

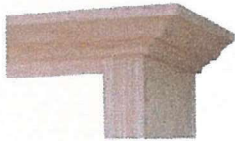

Executive Detail (Fluted Sides)

Executive Bookcase Wall

RR9684EX-12 12 Total Adj Shelves
Inset Doors
100w x 84t x 14d (Outside Dimensions)
Also Available 16" Deep



Embassy Detail

Embassy Bookcase Wall

RR9684EMB-12 12 Total Adj Shelves
Inset Raised Panel Doors
101w x 84t x 14 1/2d
Also Available 16" Deep

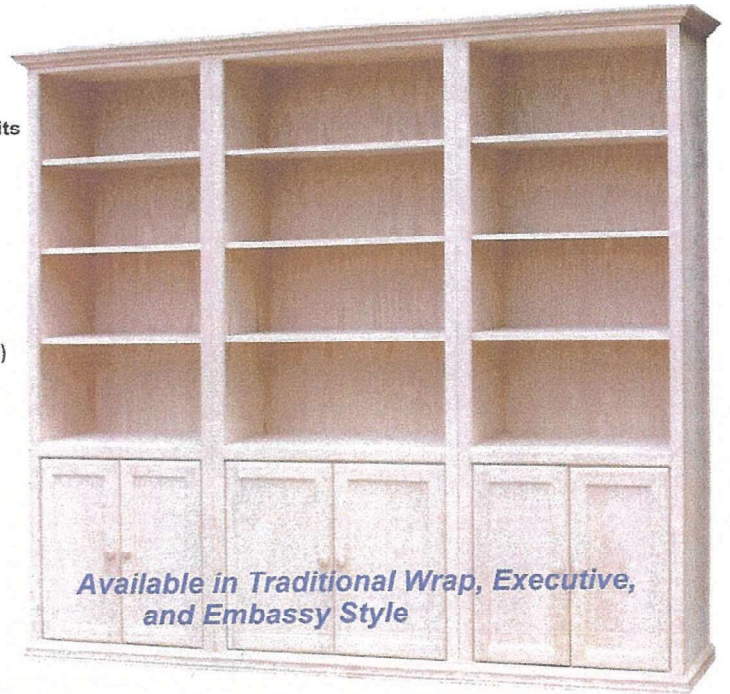

*Available in Traditional Wrap, Executive,
and Embassy Style*



BOOKCASES

Yarbrough Furniture Designs, Inc

BOOKCASES

Embassy Wall Unit

TRW Wall Unit





BOOKCASES

Yarbrough Furniture Designs, Inc

BOOKCASES

Bookcases come in a wide variety of standard dimensions shown below. Bookcases that are wider than 42" will have a single upright but can also have double uprights. You can also have dimensions (i.e, non-standard dimensions) that are in between the dimensions shown. When choosing a non-standard dimension, please use whole numbers (no fractions), for example width 22", or height 46".

ALL BOOKCASE & HUTCH DIMENSIONS ARE CASE SIZE ONLY, i.e. MOLDING SIZE IS NOT INCLUDED.

BOOKCASE - No Uprights

STANDARD WIDTHS: 18", 24", 30", 32", 36", 42"

STANDARD HEIGHTS:
24", 30", 36", 42", 48", 54",
60", 66", 72", 78", 84", 90", 96"

STANDARD DEPTHS:
10", 12", 16", 20", 24"

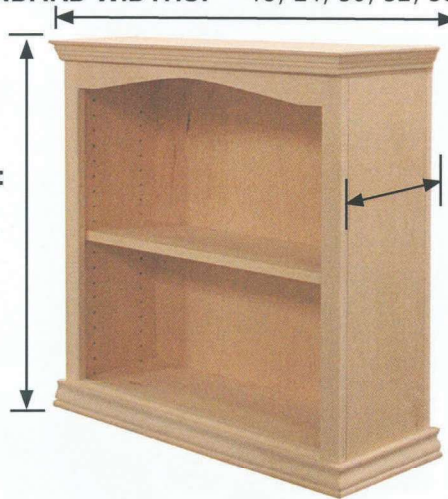

BOOKCASE - Single Upright

STANDARD WIDTHS: 48", 54", 60"

STANDARD HEIGHTS:
24", 30", 36", 42", 48", 54",
60", 66", 72", 78", 84", 90", 96"

STANDARD DEPTHS:
10", 12", 16", 20", 24"



BOOKCASE - Double Upright

STANDARD WIDTHS: 48", 54", 60"

STANDARD HEIGHTS:
24", 30", 36", 42", 48", 54",
60", 66", 72", 78", 84", 90", 96"

STANDARD DEPTHS:
10", 12", 16", 20", 24"

Shown below are the "openings" measurements for the following Double Upright widths:
48", 54" and 60"



BOOKCASE WIDTH

43"-47" wide:	12"	less than 17"	12"
48" wide:	12"	17"	12"
49"-53" wide:	14"	more than 17"	14"
54" wide:	14"	19"	14"
55"-59" wide:	14"	less than 25"	14"
60" wide:	14"	25"	14"
61"-96" wide:	more than 14"	25"	more than 14"

*****Please Note: Openings will vary according to face frame style. These openings apply only to styles with a 1 3/4" face frame. eg., /CT, /H, /R.**



BOOKCASES

Yarbrough Furniture Designs, Inc

HUTCHES

Hutches also come in a wide variety of standard dimensions shown below. Hutches wider than 42" will have one or two uprights for additional support. You can also have dimensions (i.e, non-standard dimensions) that are in between the dimensions shown. When choosing a non-standard dimension, please use whole numbers (no fractions), for example width 22", or height 46".

HUTCHES - No Uprights

STANDARD WIDTHS: 18", 24", 30", 32", 36", 42"

STANDARD HEIGHTS:

24", 30", 36", 42", 48", 54",
60", 66", 72", 78", 84", 90", 96"

STANDARD DEPTHS:

10", 12", 16", 20", 24"

Permanent Shelf
Permanent Shelf Heights
(standard)
0", 1", 15", 20", 31"

PLEASE NOTE:

(Hutches wider than 42" with uprights)
For Hutches with a Permanent Shelf, the upright will extend to the Permanent Shelf only. Hutches with no Permanent Shelf, 0", or the Permanent Shelf at 1", uprights will extend to the bottom of the hutch.

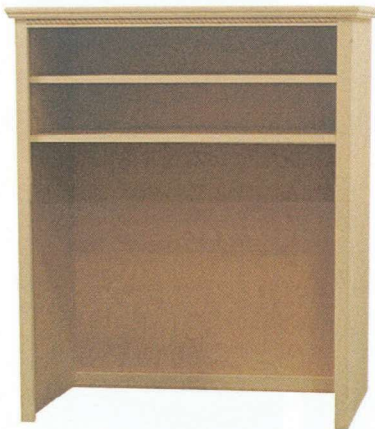
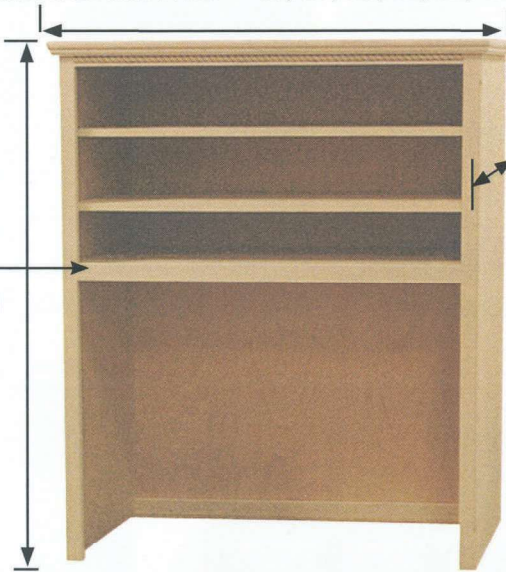

This Hutch is shown with no Permanent Shelf, i.e. at 0". HCH0



This Hutch is shown with the Permanent Shelf at 1". This shelf will be at the bottom of the hutch. HCH1.



This Hutch is shown with the Permanent Shelf at 31". The Permanent Shelf can also be at 15" or 20".





BOOKCASES

Yarbrough Furniture Designs, Inc

DOORS can be added to any bookcase. Inwood Furniture offers a variety of doors shown below. Adding doors to your bookcases gives your bookcases an extra dimension. Please choose your doors from the styles offered.

NOTE: **ARCHED** doors are NOT offered smaller than 14" wide.
CURVED doors are NOT offered smaller than 11" wide.
MULLION doors are NOT offered smaller than 14" wide.
RAISED PANEL doors are NOT offered smaller than 10' wide.



Arched Bead Door/ABD Arched Flat Door/AFD Arched Glass Door/AGD Arch Raised Door/ARD Curved Bead Door/CBD Curved Glass Door/CGD

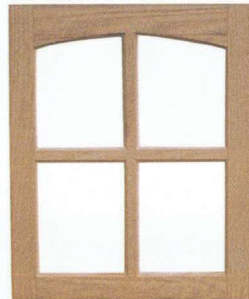

Curved Flat Door/CFD Curved Raised Door/CRD Mullion Curved Door/MCD Bead Board Door/BBD Finger Grooved Door/FGD

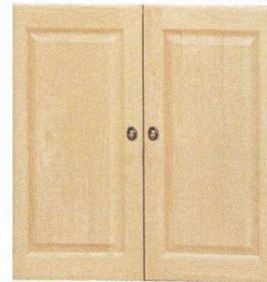
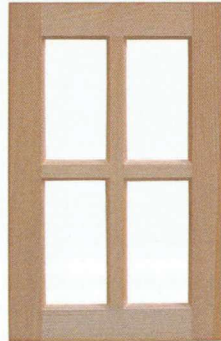
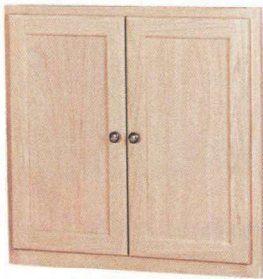

Flat Panel Door/FPD Glass Panel Door/GPD Mullion Panel Door/MPD Raised Panel Door/RPD Slab Door/SLD



Mission FP Door



BOOKCASES

Yarbrough Furniture Designs, Inc

DRAWERS can be added to any bookcase. Drawers are offered with the profiles shown below. All Inwood Furniture drawers are Dove-tailed construction (except Solid Pine) for extra sturdiness and durability.

PROFILES FOR DOORS AND DRAWERS



Rounded Profile



Colonial Profile



Square Profile



DRAWER FRONTS



Slab Drawer Front/SLDW



Finger Grooved Drawer Front/FGDW

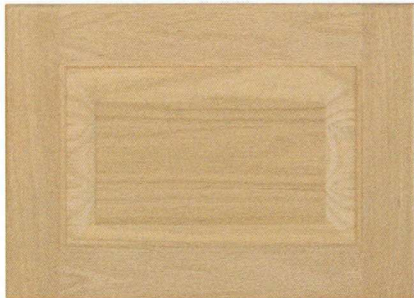

Raised Panel Drawer Front/RPDW



Square Flat Panel Drawer Front/FPDW



Bead Board Drawer Front/BBDW

Example
Raised Panel Drawer Front/RPDW





BOOKCASES

Yarbrough Furniture Designs, Inc

Corner units add interest and variety as well as a practical element to Bookcase Groupings. We offer different styles of corner units to suit every need and purpose. These corner units are offered in the following heights: 24", 30", 36", 42", 48", 54", 60", 66", 72", 78", 84", 90", 96", and the widths and depths shown.

NOTE: Corner unit heights ONLY can be in-between standard heights offered. When choosing a non-standard height please use whole numbers only (no fractions) e.g 28"

Corner, CC_
Offered in 12" deep only.

TOP VIEW

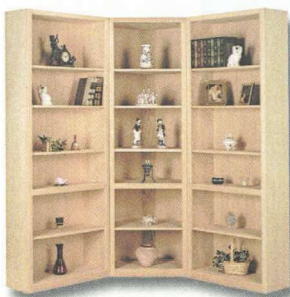
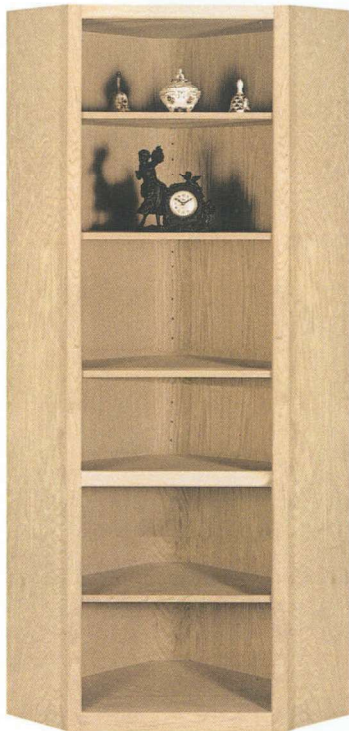
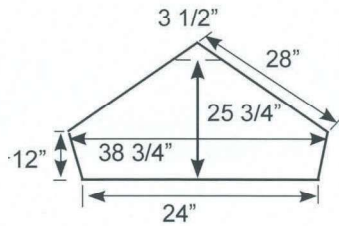

Endcap, CC_CAP
Offered in 12" and 16" deep only.

TOP VIEW

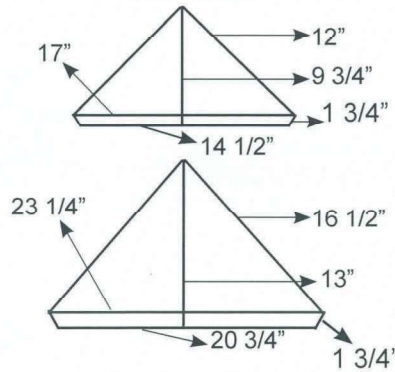

L-Shape, L_
Offered in 10", 12", 16" and 20" deep.

TOP VIEW

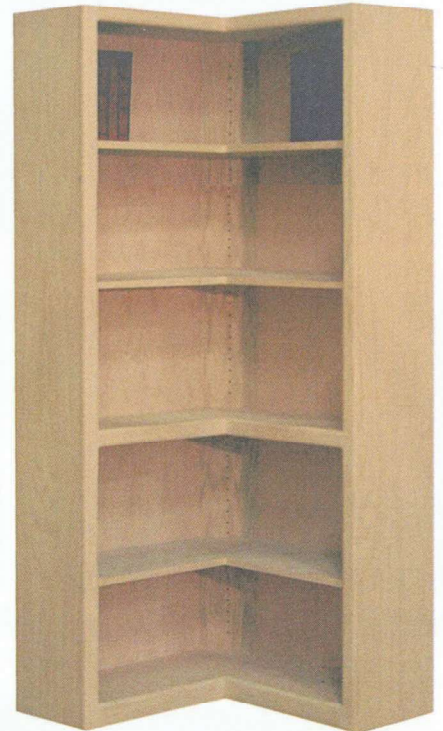
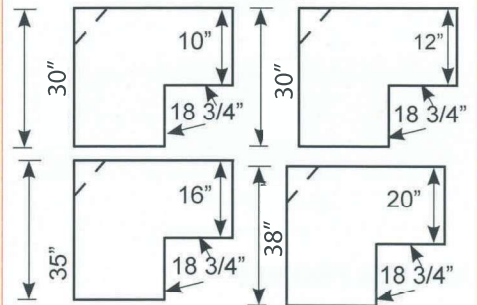



BOOKCASES

Yarbrough Furniture Designs, Inc

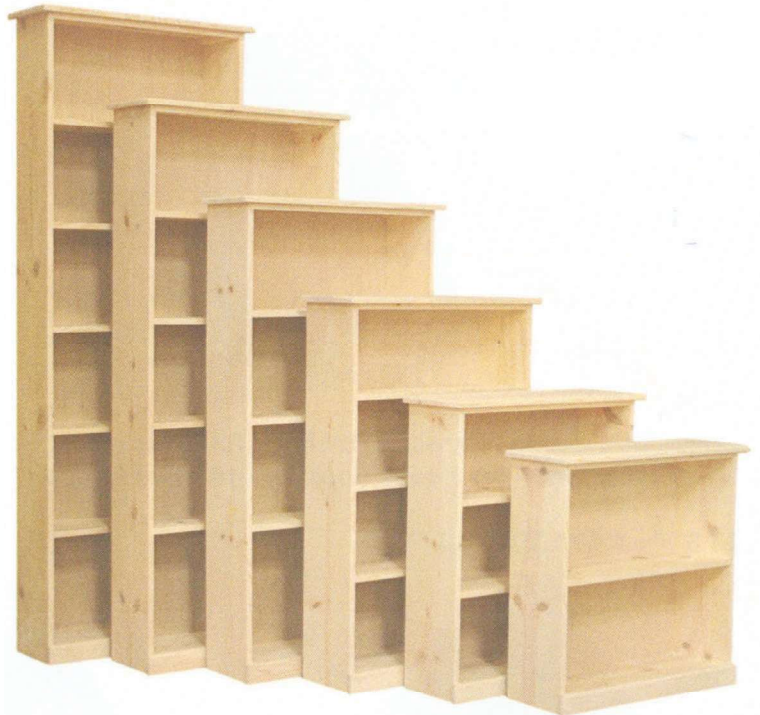

Traditional Plywood Bookcases With Arch Glass Doors

Available depths: (not including crown molding)
/12", /16", /20", /24"



SP1830	18"w x 30"h x 10"d	SP2430	24"w x 30"h x 10"d
SP1836	18"w x 36"h x 10"d	SP2436	24"w x 36"h x 10"d
SP1848	18"w x 48"h x 10"d	SP2448	24"w x 48"h x 10"d
SP1860	18"w x 60"h x 10"d	SP2460	24"w x 60"h x 10"d
SP1872	18"w x 72"h x 10"d	SP2472	24"w x 72"h x 10"d
SP1884	18"w x 84"h x 10"d	SP2484	24"w x 84"h x 10"d

SP3030	30"w x 30"h x 10"d	SP3630	36"w x 30"h x 10"d
SP3036	30"w x 36"h x 10"d	SP3636	36"w x 36"h x 10"d
SP3048	30"w x 48"h x 10"d	SP3648	36"w x 48"h x 10"d
SP3060	30"w x 60"h x 10"d	SP3660	36"w x 60"h x 10"d
SP3072	30"w x 72"h x 10"d	SP3672	36"w x 72"h x 10"d
SP3084	30"w x 84"h x 10"d	SP3684	36"w x 84"h x 10"d

SP4230	42"w x 30"h x 10"d
SP4236	42"w x 36"h x 10"d
SP4248	42"w x 48"h x 10"d
SP4260	42"w x 60"h x 10"d
SP4272	42"w x 72"h x 10"d
SP4284	42"w x 84"h x 10"d

BC_3630/TRWG	38"w x 30"h x 13"d
BC_3636/TRWG	38"w x 36"h x 13"d
BC_3648/TRWG	38"w x 48"h x 13"d
BC_3660/TRWG	38"w x 60"h x 13"d
BC_3672/TRWG	38"w x 72"h x 13"d



BOOKCASES Yarbrough Furniture Designs, Inc

Housewidy
49" w x 46" m x 12" d



Flat Top bookcase
34 1/2" w x 48" h x 10 1/4" d

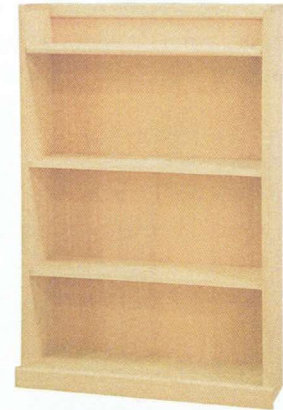

House Bookcases - Plywood Rooftop. All dimensions the same, unless stated otherwise
Use /Flat to order any House bookcase as a Flat top. **NOTE: CROSS GRAINED SHELVES MAY BE USED**

30" w x 62" m x 10" d

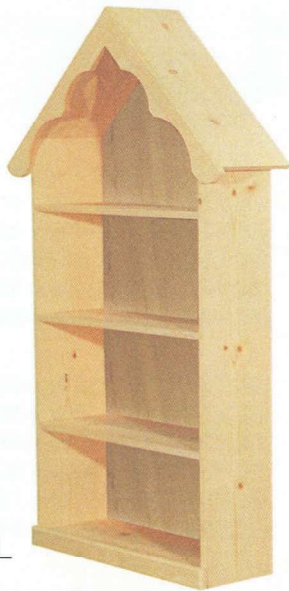

HOUSE_

Media Storage

MS_2430	24" w x 30" h x 8" d
MS_2436	24" w x 36" h x 8" d
MS_2448	24" w x 48" h x 8" d
MS_2460	24" w x 60" h x 8" d
MS_2472	24" w x 72" h x 8" d

NOTE: CROSS GRAINED SHELVES MAY BE USED





BOOKCASES

Yarbrough Furniture Designs, Inc

Arch/AC No molding on the top or bottom.

Bookcases taller than 66" have a permanent shelf 30" from the ground. Bookcases 67" and taller, have no finished top unless specified.

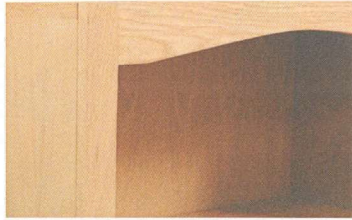

Arch - TRW/ACT Full wrap top and bottom molding.

Bookcases taller than 66" will have a permanent shelf 30" from the ground. Bookcases 67" and taller, have no finished top unless specified.



Flared molding is used for bookcases taller than 66".

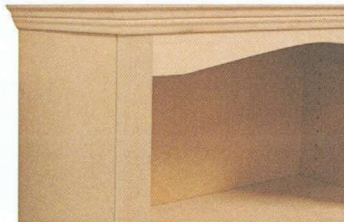

Flat molding is used for all bookcases 66" or less.



Basic/BA No molding on the top or bottom.

Bookcases taller than 66" have a permanent shelf 30" from the ground. Bookcases 67" and taller, have no finished top unless specified.

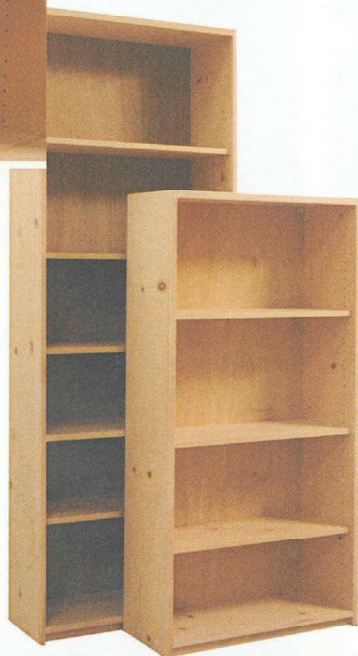
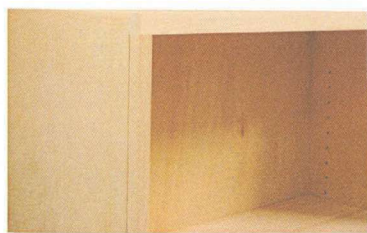

Cottage/CE Full wrap top and bottom molding.

Bookcases taller than 66" have a permanent shelf 30" from the ground. Bookcases 67" and taller, have no finished top unless specified.



Flared molding is used for bookcases taller than 66".



Flat molding is used for all bookcases 66" or less.





BOOKCASES

Yarbrough Furniture Designs, Inc

Contemporary/CT No molding on the top or bottom.

Bookcases taller than 66" have a permanent shelf 30" from the ground. Bookcases 67" and taller, have no finished top unless specified.

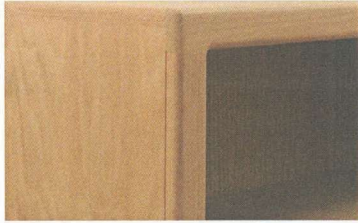

Crown/CR Top and bottom molding on front only.

Bookcases taller than 66" will have a permanent shelf 30" from the ground. Bookcases 67" and taller, have no finished top unless specified.



molding is used for all bookcases 66" or less.

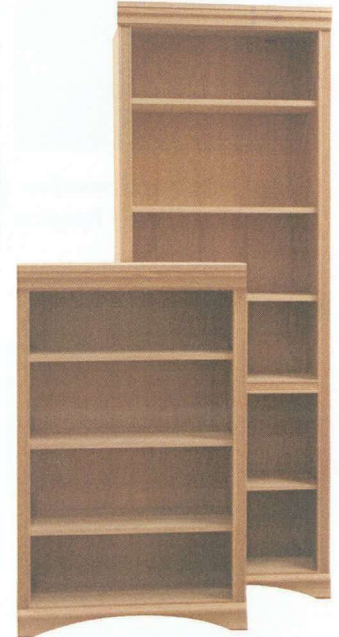

Classic 1/C1 Full wrap top and bottom molding.

Bookcases taller than 66" have a permanent shelf 30" from the ground. This bookcase style has a finished top on all heights.



Same top and bottom molding for all heights



Classic 1 Dentil/C1D Full wrap top and bottom molding.

Bookcases taller than 66" have a permanent shelf 30" from the ground. This bookcase style has a finished top on all heights.



Same top and bottom molding for all heights





BOOKCASES

Yarbrough Furniture Designs, Inc

Classic 1 Rope/C1P Full wrap top and bottom molding.

Bookcases taller than 66" have a permanent shelf 30" from the ground. This bookcase style has a finished top for all heights.



Same top and bottom molding for all heights

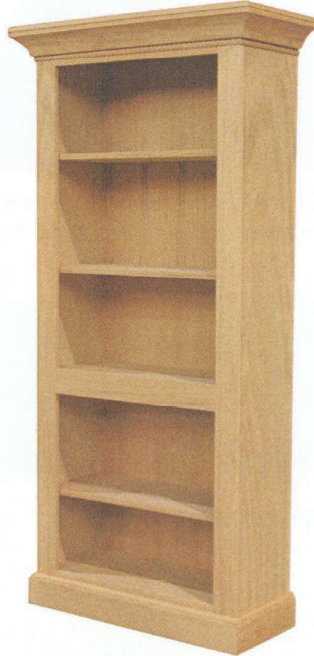

Classic 2/C2 Full wrap top and bottom molding.

Bookcases taller than 66" have a permanent shelf 30" from the ground. This bookcase style has a finished top for all heights.



Same top and bottom molding for all heights



Classic 2 Dentil/C2D Full wrap top and bottom molding.

Bookcases taller than 66" have a permanent shelf 30" from the ground. This bookcase style has a finished top for all heights.



Same top and bottom molding for all heights

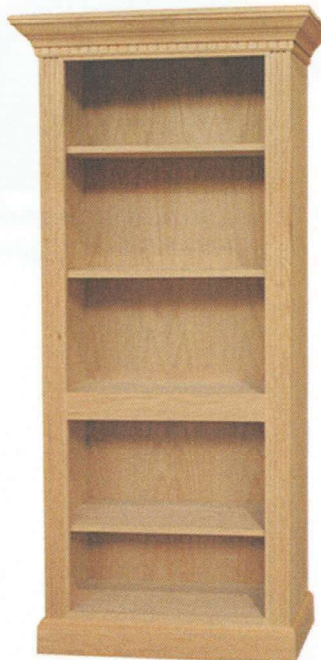

Classic 2 Rope/C2P Full wrap top and bottom molding.

Bookcases taller than 66" have a permanent shelf 30" from the ground. This bookcase style has a finished top for all heights.



Same top and bottom molding for all heights

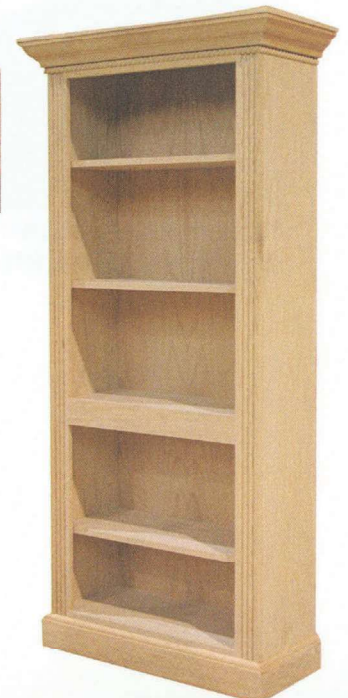



BOOKCASES

Yarbrough Furniture Designs, Inc

Fluted/FT Full wrap top and bottom molding.

Bookcases taller than 66" have a permanent shelf 30" from the ground. Bookcases 67" and taller, have no finished top unless specified.



molding is used for bookcases taller than 66".



400

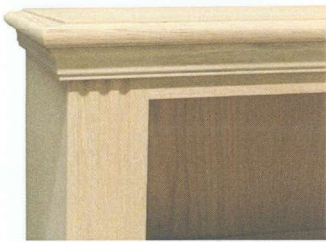

molding is used for all bookcases 66" or less.

Harvard/HV Full wrap top and bottom molding.

Bookcases taller than 66" have a permanent shelf 30" from the ground. Bookcases 67" and taller, have no finished top unless specified.



Flared molding is used for bookcases taller than 66".

400 Finish Top



molding is used for all bookcases 66" or less.



Heritage/H Top and bottom molding on front only.

Bookcases taller than 66" have a permanent shelf 30" from the ground. Bookcases 67" and taller, have no finished top unless specified.



Same molding for all heights



Heritage Rope/HP Top and bottom molding on front only.

Bookcases taller than 66" have a permanent shelf 30" from the ground. Bookcases 67" and taller, have no finished top unless specified.



Same molding for all heights





BOOKCASES

Yarbrough Furniture Designs, Inc

Regal/RE Full wrap top molding only.

Bookcases taller than 66" have a permanent shelf 30" from the ground. Bookcases 67" and taller, have no finished top unless specified.



Flared molding is used for bookcases taller than 66".



Flat molding is used for all bookcases 66" or less.



Rosette/R Top and bottom molding on front only.

Bookcases taller than 66" will have a permanent shelf 30" from the ground. Bookcases 67" and taller, have no finished top unless specified.



Same molding for all heights



Rosette Rope/RP Top and bottom molding on front only. Shaker/SH Full wrap top molding only.

Bookcases taller than 66" have a permanent shelf 30" from the ground. Bookcases 67" and taller, have no finished top unless specified.



Same molding for all heights

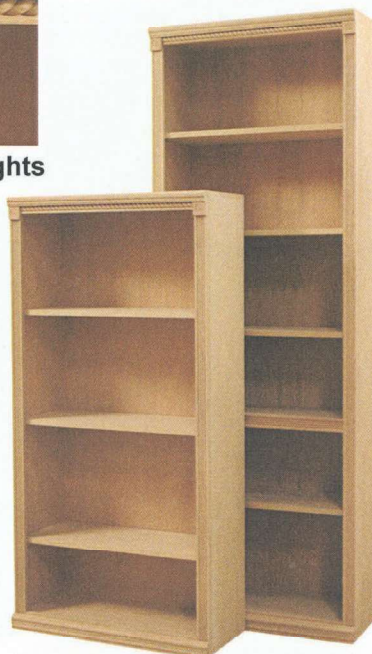

Bookcases taller than 66" have a permanent shelf 30" from the ground. **This bookcase style has a finished top on all heights.**

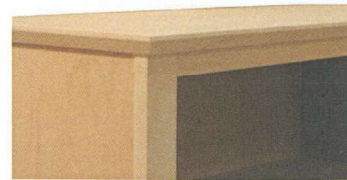

Same molding for all heights





BOOKCASES

Yarbrough Furniture Designs, Inc

TRW Fluted Rope/TFP Full wrap top and bottom molding.

Bookcases taller than 66" have a permanent shelf 30" from the ground. Bookcases 67" and taller, have no finished top unless specified.



Flared molding is used for bookcases taller than 66".



Flat molding is used for all bookcases 66" or less.



TRW Rope/TP Full wrap top and bottom molding.

Bookcases taller than 66" have a permanent shelf 30" from the ground. Bookcases 67" and taller, have no finished top unless specified.



Flared molding is used for bookcases taller than 66".



Flat molding is used for all bookcases 66" or less.

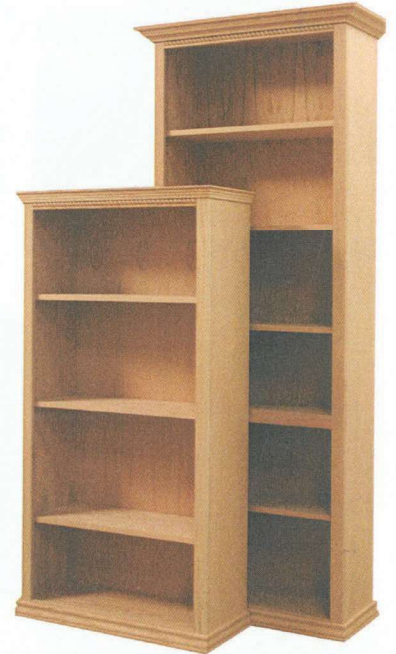

Traditional Wrap/TRW Full wrap top and bottom molding.

Bookcases taller than 66" have a permanent shelf 30" from the ground. Bookcases 67" and taller, have no finished top unless specified.

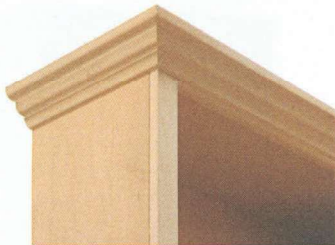

Flared molding is used for bookcases taller than 66".



Flat molding is used for all bookcases 66" or less.



New Traditional Wrap/NTW Full wrap top and bottom molding.

Bookcases taller than 66" have a permanent shelf 30" from the ground. Bookcases 67" and taller, have no finished top unless specified.



Flared molding is used for bookcases taller than 66".



Flat molding is used for all bookcases 66" or less.





BOOKCASES

Yarbrough Furniture Designs, Inc

New Shaker/NSH Full wrap top molding only.

Bookcases taller than 66" have a permanent shelf 30" from the ground. This bookcase style has a finished top for all heights.



Same molding for all heights

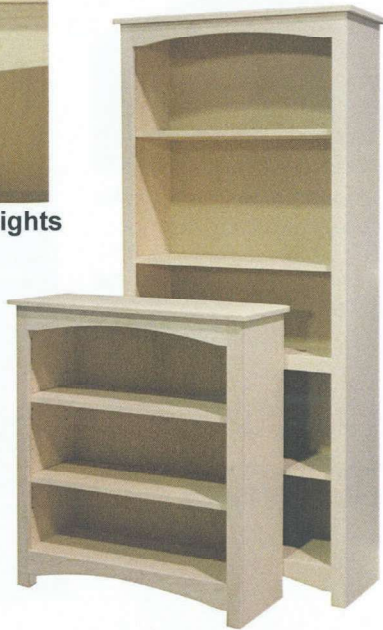

Traditional/TR Top and bottom molding on front only.

Bookcases taller than 66" have a permanent shelf 30" from the ground. Bookcases 67" and taller, have no finished top unless specified.

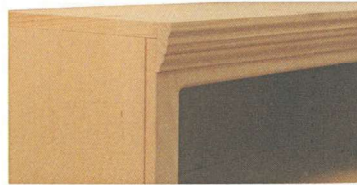

Same molding for all heights



TRW Fluted/TF Full wrap top and bottom molding.

Bookcases taller than 66" have a permanent shelf 30" from the ground. Bookcases 67" and taller, have no finished top unless specified.



Flared molding is used for bookcases taller than 66".



Flat molding is used for all bookcases 66" or less.



BOOKCASES Yarbrough Furniture Designs, Inc

Vintage/VT Full wrap top molding only.

Bookcases taller than 66" have a permanent shelf 30" from the ground. Bookcases 67" and taller, have no finished top unless specified.

New Vintage/NVT Full wrap top and bottom molding.

Bookcases taller than 66" have a permanent shelf 30" from the ground. Bookcases 67" and taller, have no finished top unless specified.



Flared molding is used for bookcases taller than 66".



Flared molding is used for bookcases taller than 66".



Flat molding is used for all bookcases 66" or less.



Flat molding is used for all bookcases 66" or less.

Hampshire/HM Full wrap top and bottom molding.

Bookcases taller than 66" have a permanent shelf 30" from the ground. This bookcase style has a finished top for all heights.



Flared molding is used for bookcases taller than 66".

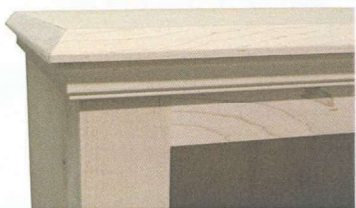

Flat molding is used for all bookcases 66" or less.